

Introduction to Tokyo Products

Mikio Hirabayashi

<hirarin@gmail.com>

Tokyo Products

- **Tokyo Cabinet**
 - database library
- **Tokyo Tyrant**
 - database server
- **Tokyo Dystopia**
 - full-text search engine
- **Tokyo Promenade**
 - content management system
- **open source**
 - released under LGPL
- **powerful, portable, practical**
 - written in the standard C, optimized to POSIX

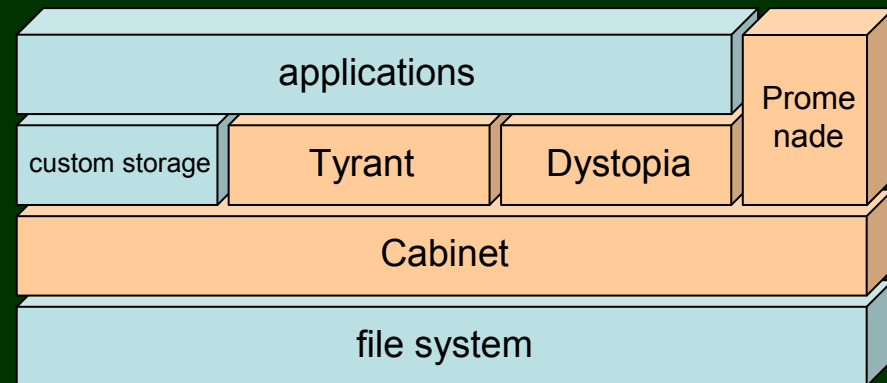

Tokyo Cabinet

- database library -

Features

- **modern implementation of DBM**
 - **key / value database**
 - e.g.) DBM, NDBM, GDBM, TDB, CDB, Berkeley DB
 - **simple library = process embedded**
 - **Successor of QDBM**
 - C99 and POSIX compatible, using Pthread, mmap, etc...
 - Win32 porting was abolished (inherited to KC)
- **high performance**
 - **insert: 0.4 sec / 1M records (2,500,000 qps)**
 - **search: 0.33 sec / 1M records (3,000,000 qps)**

- **high concurrency**
 - multi-thread safe
 - read/write locking by records
- **high scalability**
 - hash and B+tree structure = $O(1)$ and $O(\log N)$
 - no actual limit size of a database file (to 8 exabytes)
- **transaction**
 - write ahead logging and shadow paging
 - ACID properties
- **various APIs**
 - on-memory list/hash/tree
 - file hash/B+tree/array/table
- **script language bindings**
 - Perl, Ruby, Java, Lua, Python, PHP, Haskell, Erlang, etc...

TCHDB: Hash Database

- **static hashing**
 - $O(1)$ time complexity
- **separate chaining**
 - binary search tree
 - balances by the second hash
- **free block pool**
 - best fit allocation
 - dynamic defragmentation
- **combines mmap and pwrite / pread**
 - saves calling system calls
- **compression**
 - deflate(gzip) / bzip2 / custom

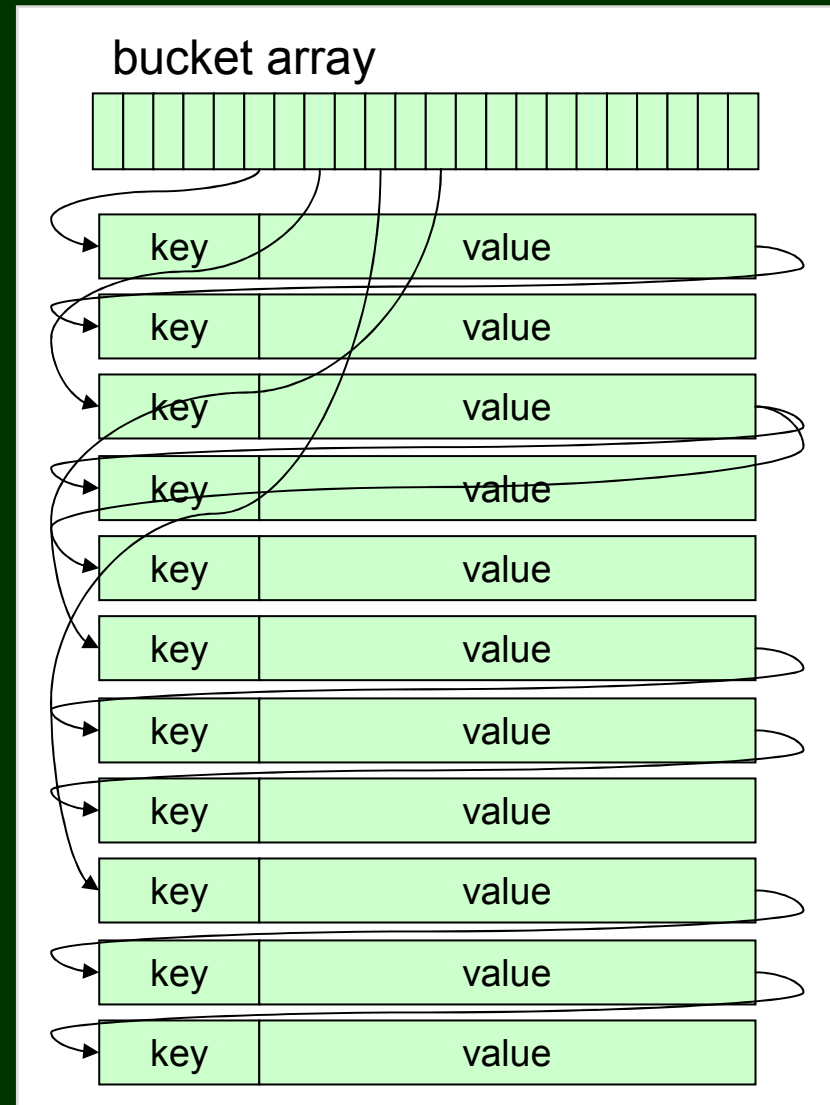

TCBDB: B+ Tree Database

- **B+ tree**
 - $O(\log N)$ time complexity
- **page caching**
 - LRU removing
 - speculative search
- **stands on hash DB**
 - records pages in hash DB
 - succeeds time and space efficiency
- **custom comparison function**
 - prefix / range matching
- **cursor**
 - jump / next / prev

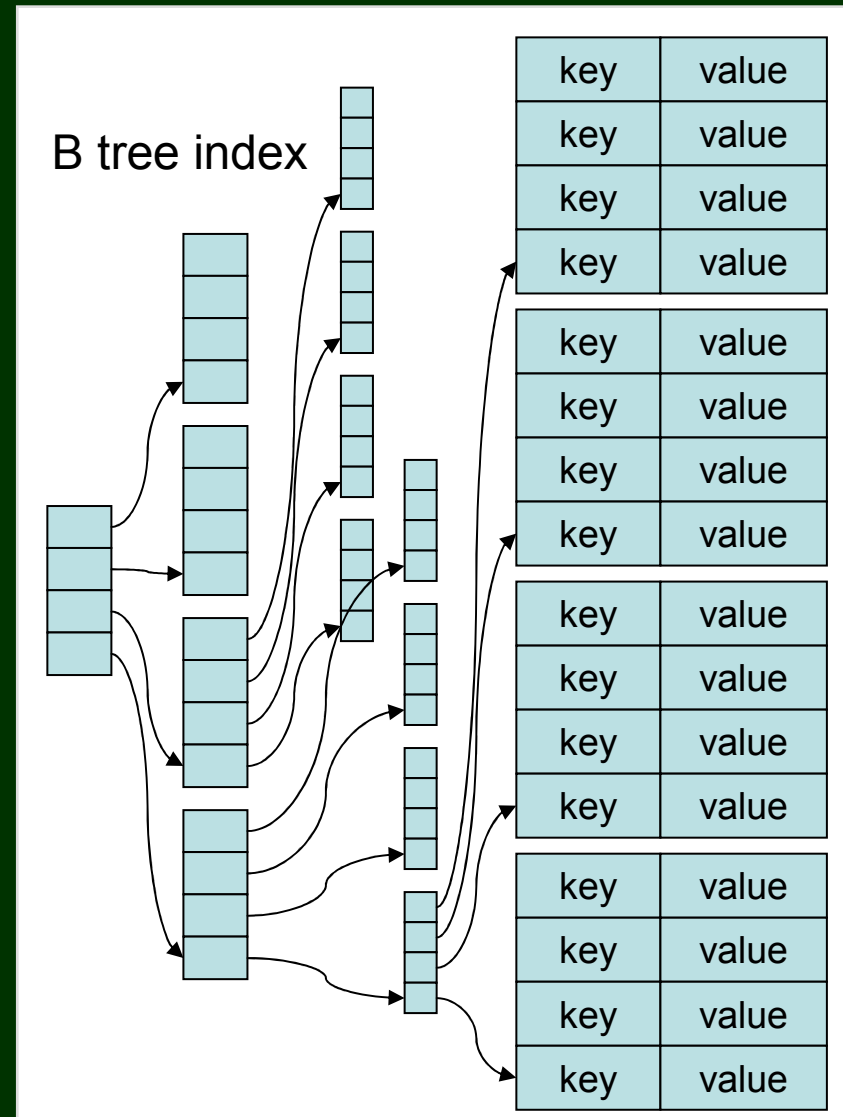

TCTDB: Table Database

- **column based**
 - the primary key and named columns
 - stands on hash DB
- **flexible structure**
 - no data scheme, no data type
 - various structure for each record
- **query mechanism**
 - various operators matching column values
 - lexical/decimal orders by column values
- **column indexes**
 - implemented with B+ tree
 - typed as string/number
 - inverted index of token/q-gram
 - query optimizer

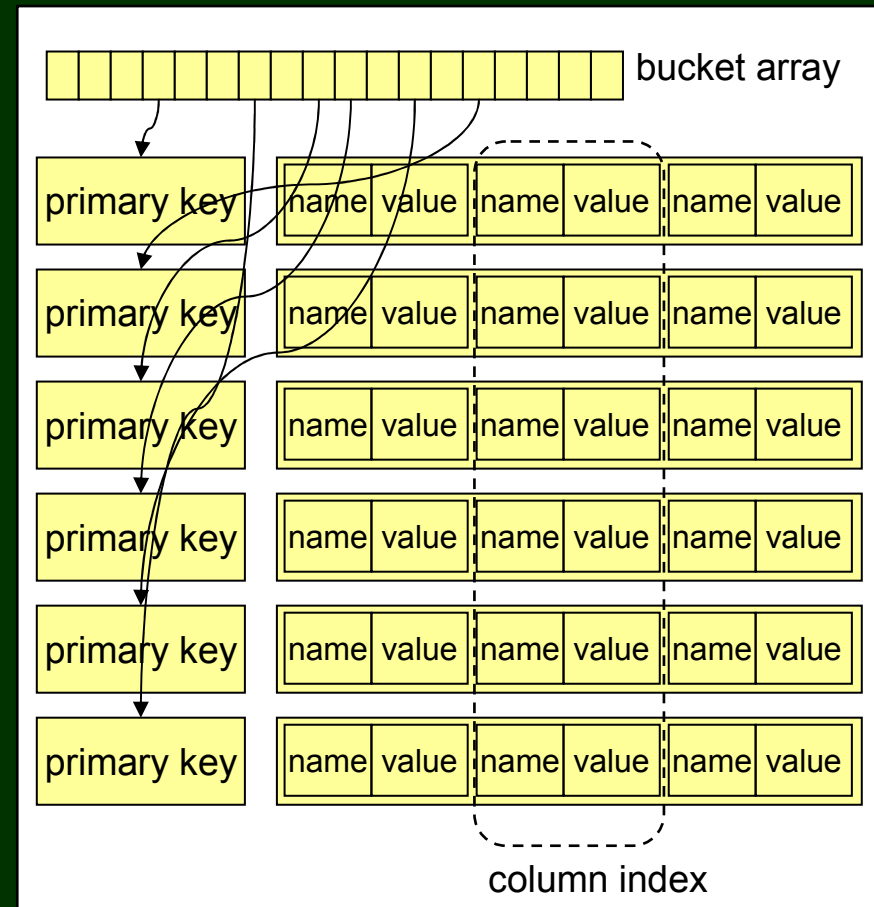

On-memory Structures

- **TCXSTR: extensible string**
 - concatenation, formatted allocation
- **TCLIST: array list (dequeue)**
 - random access by index
 - push/pop, unshift/shift, insert/remove
- **TCMAP: map of hash table**
 - insert/remove/search
 - iterator by order of insertion
- **TCTREE: map of ordered tree**
 - insert/remove/search
 - iterator by order of comparison function

Other Mechanisms

- **abstract database**
 - common interface of *b* schema
 - on-memory hash, on-memory tree
 - file hash, file B+tree, file array, file table
 - decides the concrete scheme in runtime
- **remote database**
 - network interface of the abstract database
 - yes, it's Tokyo Tyrant!
- **miscellaneous utilities**
 - string processing, filesystem operation
 - memory pool, encoding/decoding

Example Code

```
#include <tcutil.h>
#include <tchdb.h>
#include <stdlib.h>
#include <stdbool.h>
#include <stdint.h>

int main(int argc, char **argv){

    TCHDB *hdb;
    int ecode;
    char *key, *value;

    /* create the object */
    hdb = tchdbnew();

    /* open the database */
    if(!tchdbopen(hdb, "casket.hdb", HDBOWRITER | HDBOCREAT)){
        ecode = tchdbecode(hdb);
        fprintf(stderr, "open error: %s\n", tchdberrmsg(ecode));
    }

    /* store records */
    if(!tchdbput2(hdb, "foo", "hop") ||
        !tchdbput2(hdb, "bar", "step") ||
        !tchdbput2(hdb, "baz", "jump")){
        ecode = tchdbecode(hdb);
        fprintf(stderr, "put error: %s\n", tchdberrmsg(ecode));
    }

    /* retrieve records */
    value = tchdbget2(hdb, "foo");
    if(value){
        printf("%s\n", value);
        free(value);
    } else {
        ecode = tchdbecode(hdb);
        fprintf(stderr, "get error: %s\n", tchdberrmsg(ecode));
    }
}
```

```
/* traverse records */
tchdbiterinit(hdb);
while((key = tchdbiternext2(hdb)) != NULL){
    value = tchdbget2(hdb, key);
    if(value){
        printf("%s:%s\n", key, value);
        free(value);
    }
    free(key);
}

/* close the database */
if(!tchdbclose(hdb)){
    ecode = tchdbecode(hdb);
    fprintf(stderr, "close error: %s\n", tchdberrmsg(ecode));
}

/* delete the object */
tchdbdel(hdb);

return 0;
}
```

Tokyo Tyrant

- database server -

Features

- **network server of Tokyo Cabinet**
 - client / server model
 - multi applications can access one database
 - effective binary protocol
- **compatible protocols**
 - supports memcached protocol and HTTP
 - available from most popular languages
- **high concurrency / performance**
 - resolves "c10k" with epoll / kqueue / eventports
 - 17.2 sec / 1M queries (58,000 qps)

- **high availability**
 - hot backup and update log
 - asynchronous replication between servers
- **various database schema**
 - using the abstract database API of Tokyo Cabinet
- **effective operations**
 - no-reply updating, multi-record retrieval
 - atomic increment
- **Lua extension**
 - defines arbitrary database operations
 - atomic operation by record locking
- **pure script language interfaces**
 - Perl, Ruby, Java, Python, PHP, Erlang, etc...

Asynchronous Replication

master and slaves
(load balancing)

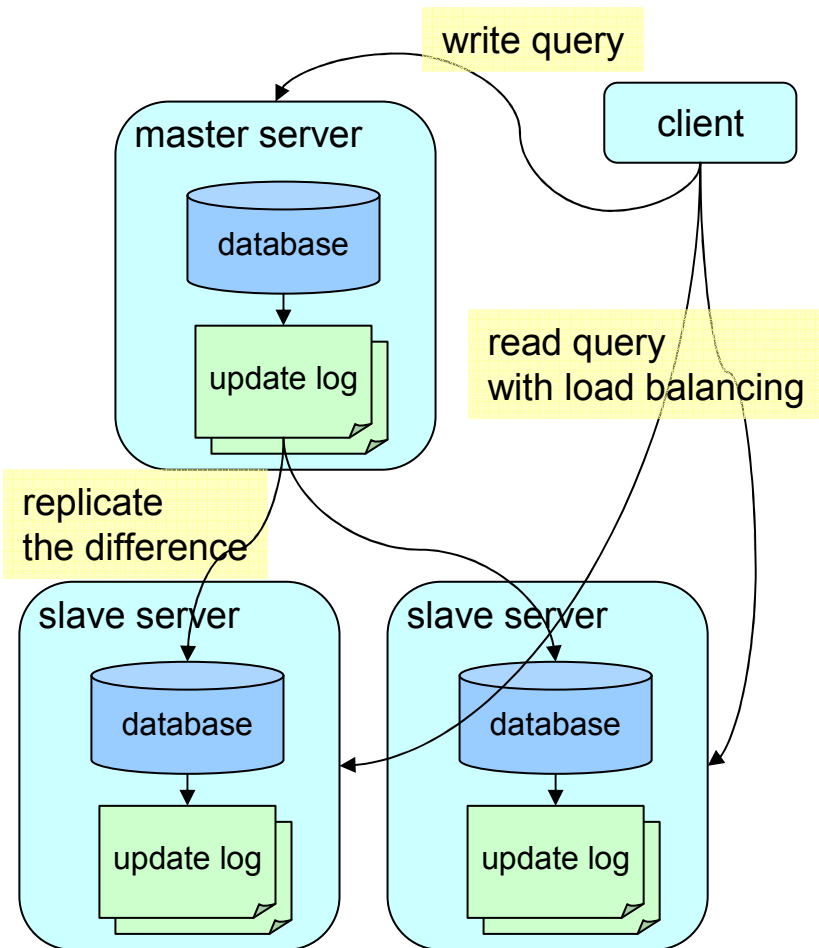

dual master
(fail over)

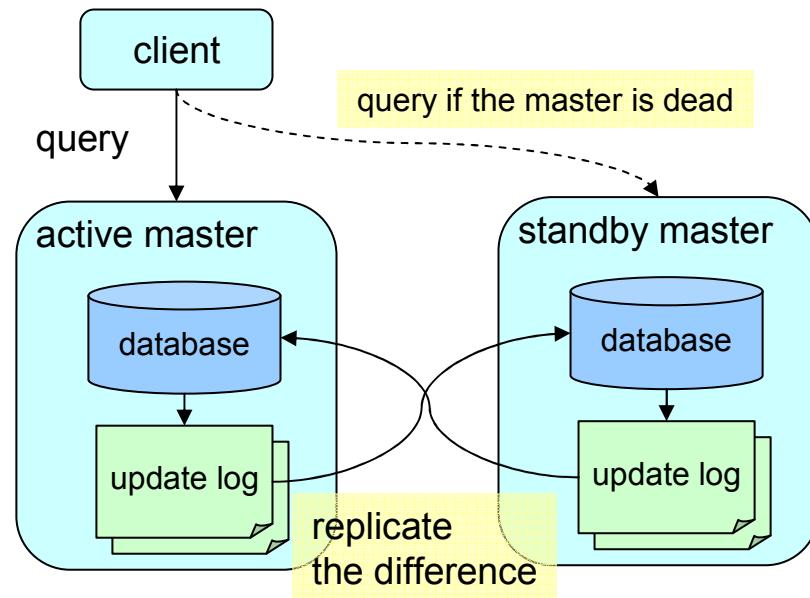

Thread Pool Model

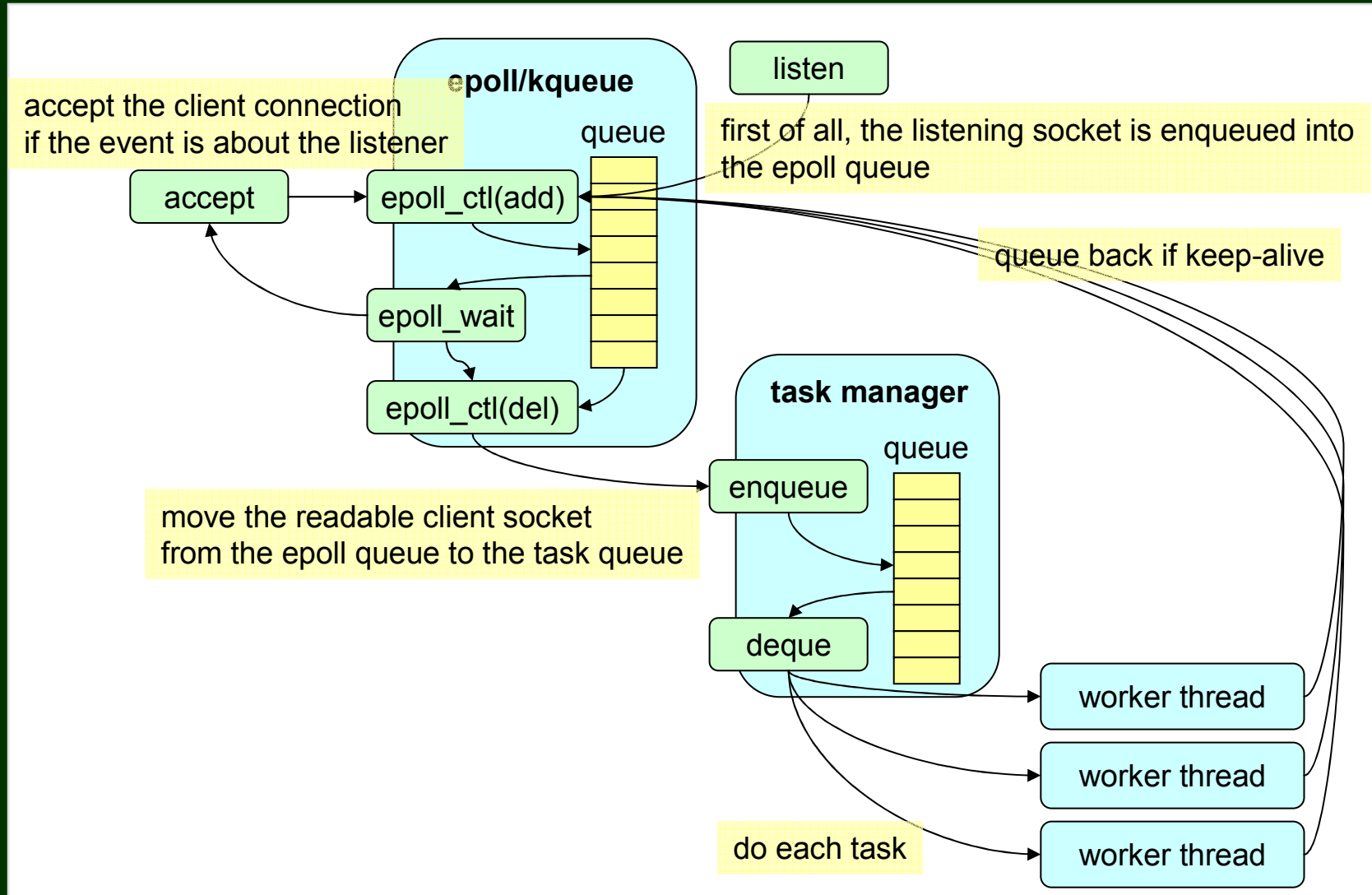

Lua Extention

- **defines DB operations as Lua functions**
 - clients send the function name and record data
 - the server returns the return value of the function
- **options about atomicity**
 - no locking / record locking / global locking

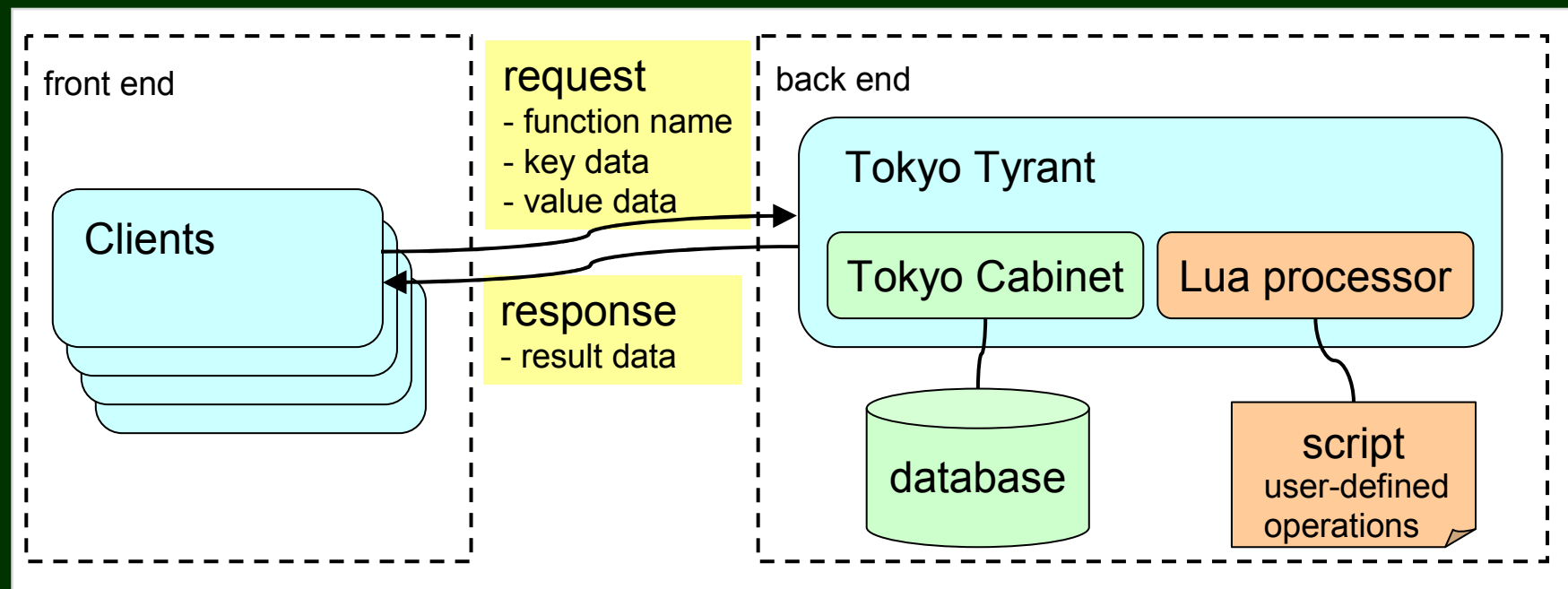

case: Timestamp DB at mixi.jp

- **20 million records**
 - each record size is 20 bytes
- **more than 10,000 updates per sec.**
 - Keeps 10,000 connections
- **dual master replication**
 - each server is only one
- **memcached compatible protocol**
 - reuses existing Perl clients

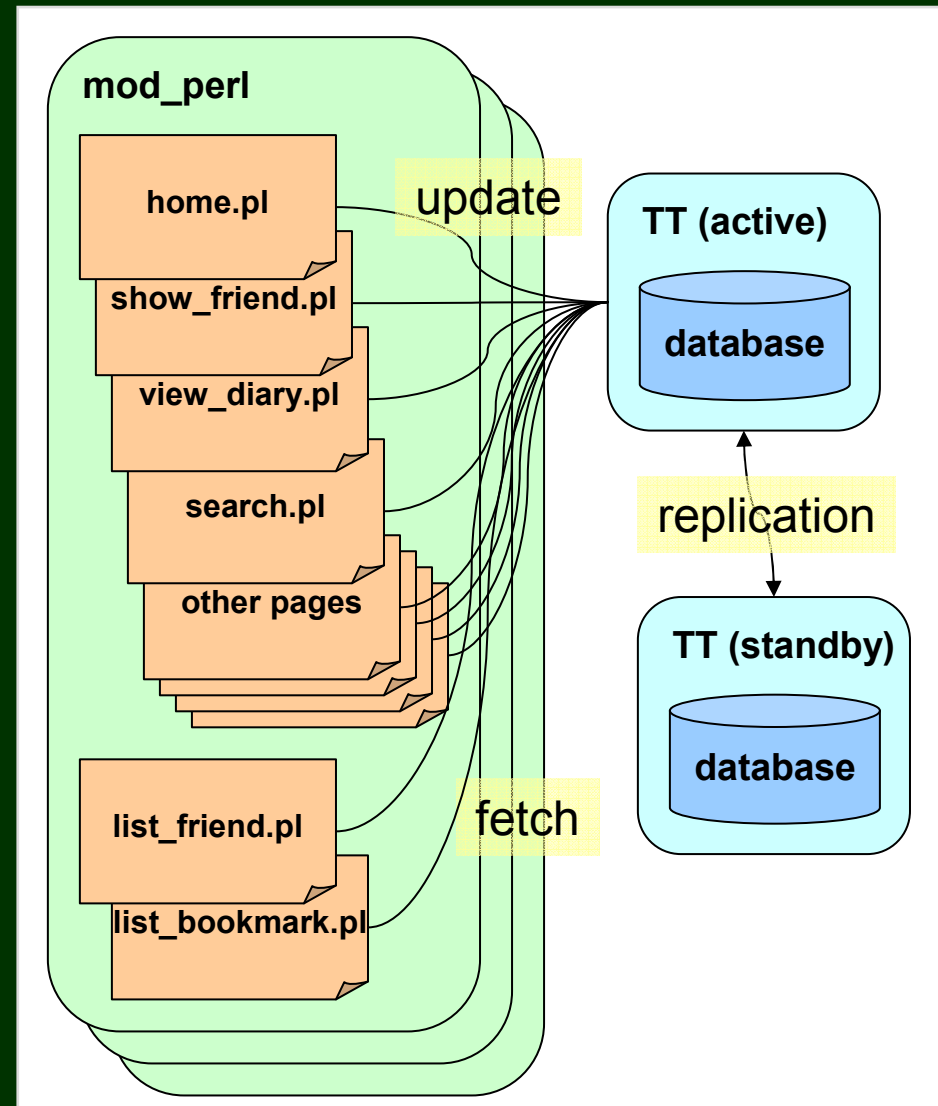

case: Cache for Big Storages

- **works as proxy**
 - mediates insert/search
 - write through, read through
- **Lua extension**
 - atomic operation by record locking
 - uses LuaSocket to access the storage
- **proper DB scheme**
 - TCMDB: for generic cache
 - TCNDB: for biased access
 - TCHDB: for large records such as image
 - TCFDB: for small records such as timestamp

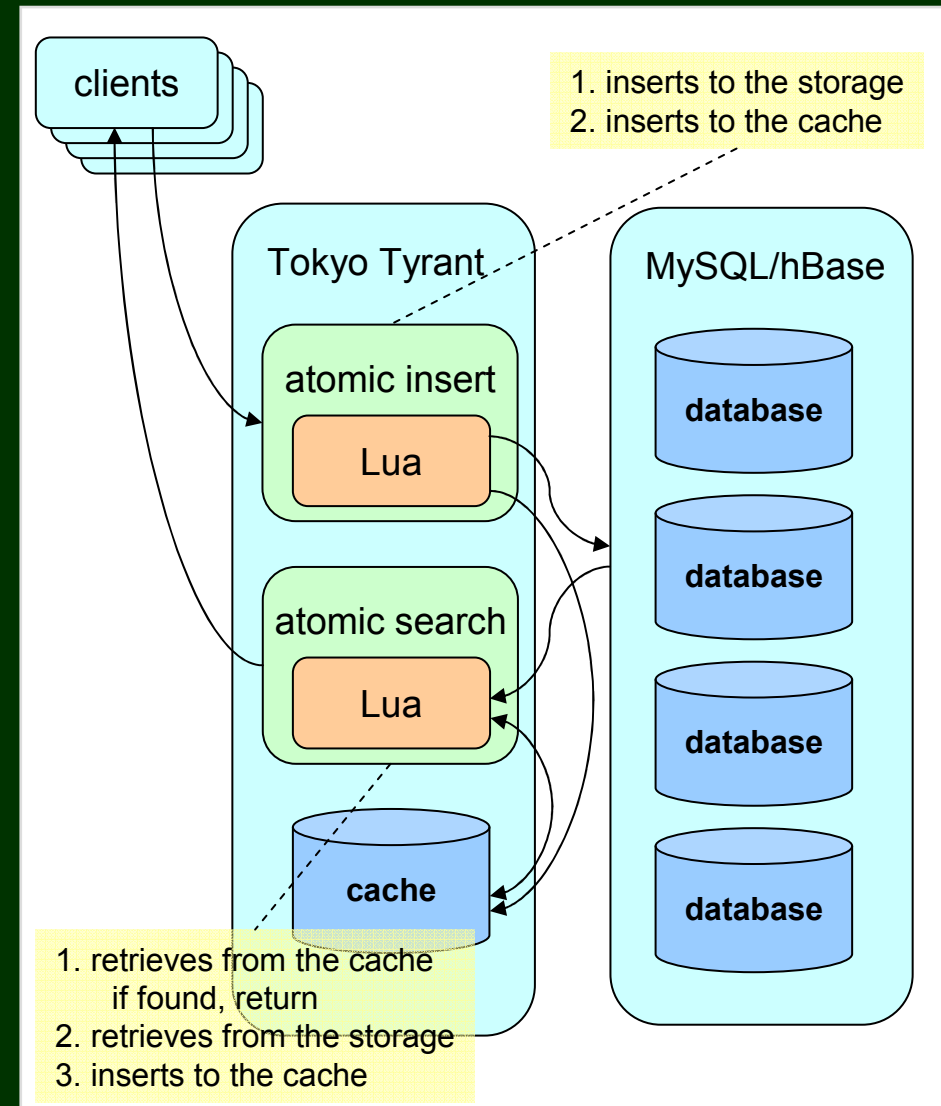

Example Code

```
#include <tcldb.h>
#include <stdlib.h>
#include <stdbool.h>
#include <stdint.h>

int main(int argc, char **argv){

    TCRDB *rdb;
    int ecode;
    char *value;

    /* create the object */
    rdb = tcldbnew();

    /* connect to the server */
    if(!tcldbopen(rdb, "localhost", 1978)){
        ecode = tcldbdecode(rdb);
        fprintf(stderr, "open error: %s\n", tcldberrmsg(ecode));
    }

    /* store records */
    if(!tcldbput2(rdb, "foo", "hop") ||
        !tcldbput2(rdb, "bar", "step") ||
        !tcldbput2(rdb, "baz", "jump")){
        ecode = tcldbdecode(rdb);
        fprintf(stderr, "put error: %s\n", tcldberrmsg(ecode));
    }

    /* retrieve records */
    value = tcldbget2(rdb, "foo");
    if(value){
        printf("%s\n", value);
        free(value);
    } else {
        ecode = tcldbdecode(rdb);
        fprintf(stderr, "get error: %s\n", tcldberrmsg(ecode));
    }
}
```

```
/* close the connection */
if(!tcldbclose(rdb)){
    ecode = tcldbdecode(rdb);
    fprintf(stderr, "close error: %s\n", tcldberrmsg(ecode));
}

/* delete the object */
tcldbdel(rdb);

return 0;
}
```

Tokyo Dystopia

- full-text search engine -

Features

- **full-text search engine**
 - manages databases of Tokyo Cabinet as an inverted index
- **combines two tokenizers**
 - character N-gram (bi-gram) method
 - perfect recall ratio
 - simple word by outer language processor
 - high accuracy and high performance
- **high performance / scalability**
 - handles more than 10 million documents
 - searches in milliseconds

- **optimized to professional use**

- layered architecture of APIs
- no embedded scoring system
 - to combine outer scoring system
- no text filter, no crawler, no language processor

- **convenient utilities**

- multilingualism with Unicode
- set operations
- phrase matching, prefix matching, suffix matching, and token matching
- command line utilities

Inverted Index

- **stands on key/value database**
 - **key = token**
 - *N-gram or simple word*
 - **value = occurrence data (posting list)**
 - *list of pairs of document number and offset in the document*
- **uses B+ tree database**
 - *reduces write operations into the disk device*
 - *enables common prefix search for tokens*
 - *delta encoding and deflate compression*

```
ID:21      text: "abracadabra"  
a   - 21:10      ca - 21:1, 21:8  
ab  - 21:0,21:7  da - 21:4  
ac  - 21:3      ra - 21:2, 21:9  
br  - 21:5
```

Layered Architecture

- **character N-gram index**
 - “q-gram index” (only index), and “indexed database”
 - uses embedded tokenizer
- **word index**
 - “word index” (only index), and “tagged index”
 - uses outer tokenizer

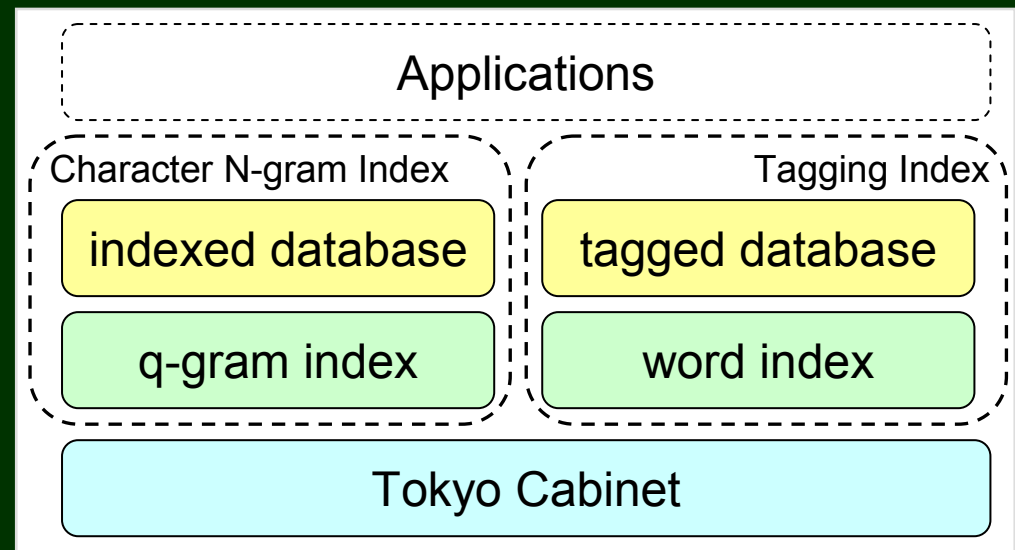

case: friend search at mixi.jp

- **20 million records**
 - each record size is 1K bytes
 - name and self introduction
- **more than 100 qps**
- **attribute narrowing**
 - gender, address, birthday
 - multiple sort orders
- **distributed processing**
 - more than 10 servers
 - indexer, searchers, merger
- **ranking by social graph**
 - the merger scores the result by following the friend links

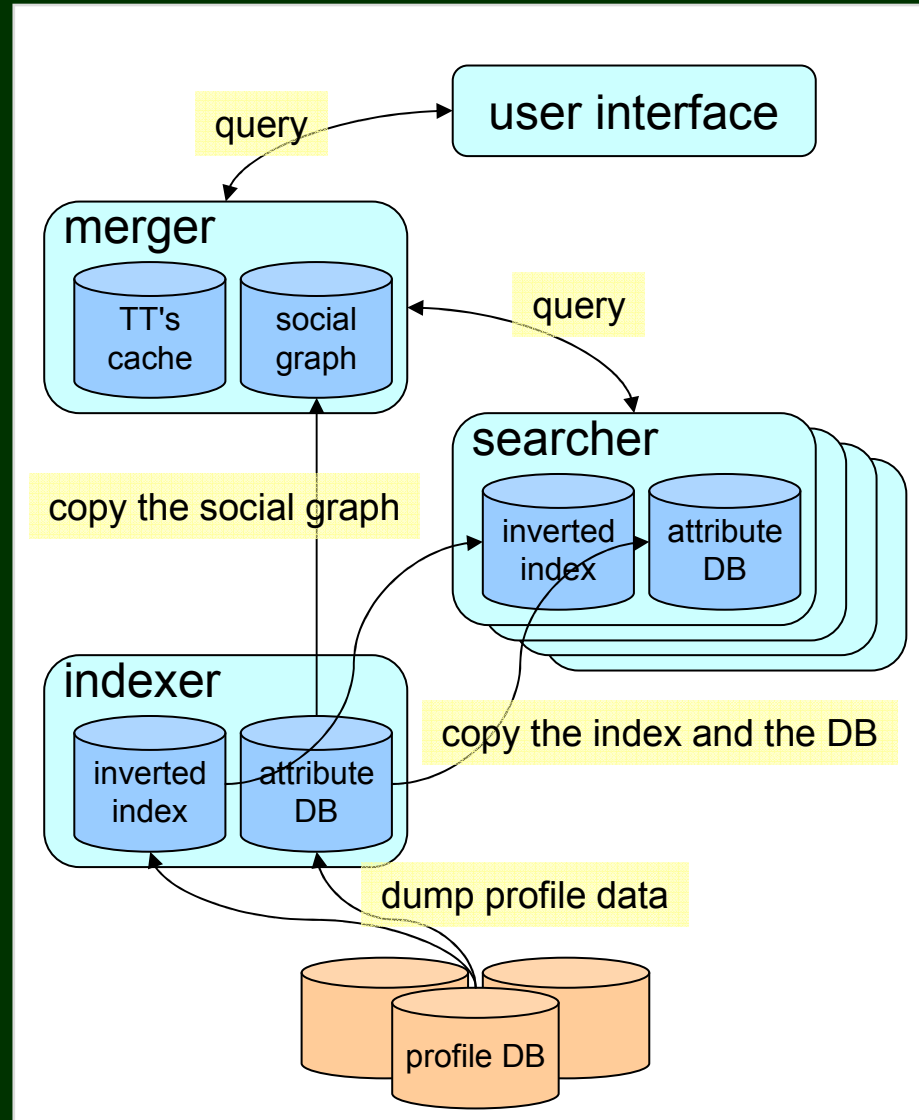

Example Code

```
#include <dystopia.h>
#include <stdlib.h>
#include <stdbool.h>
#include <stdint.h>

int main(int argc, char **argv){
    TCIDB *idb;
    int ecode, rnum, i;
    uint64_t *result;
    char *text;

    /* create the object */
    idb = tcidbnew();

    /* open the database */
    if(!tcidbopen(idb, "casket", IDBOWRITER | IDBOCREAT)){
        ecode = tcidbencode(idb);
        fprintf(stderr, "open error: %s\n", tcidberrmsg(ecode));
    }

    /* store records */
    if(!tcidbput(idb, 1, "George Washington") ||
        !tcidbput(idb, 2, "John Adams") ||
        !tcidbput(idb, 3, "Thomas Jefferson")){
        ecode = tcidbencode(idb);
        fprintf(stderr, "put error: %s\n", tcidberrmsg(ecode));
    }
}
```

```
/* search records */
result = tcidbsearch2(idb, "john || thomas", &rnum);
if(result){
    for(i = 0; i < rnum; i++){
        text = tcidbget(idb, result[i]);
        if(text){
            printf("%d\t%s\n", (int)result[i], text);
            free(text);
        }
    }
    free(result);
} else {
    ecode = tcidbencode(idb);
    fprintf(stderr, "search error: %s\n", tcidberrmsg(ecode));
}

/* close the database */
if(!tcidbclose(idb)){
    ecode = tcidbencode(idb);
    fprintf(stderr, "close error: %s\n", tcidberrmsg(ecode));
}

/* delete the object */
tcidbdel(idb);

return 0;
}
```

Tokyo Promenade

- content management system -

Features

- **content management system**
 - manages Web contents easily with a browser
 - available as BBS, Blog, and Wiki
- **simple and logical interface**
 - aims at conciseness like LaTeX
 - optimized for text browsers such as w3m and Lynx
 - complying with XHTML 1.0 and considering WCAG 1.0
- **high performance / throughput**
 - implemented in pure C
 - uses Tokyo Cabinet and supports FastCGI
 - 0.836ms/view (more than 1,000 qps)

- **sufficient functionality**

- simple Wiki formatting
- file uploader and manager
- user authentication by the login form
- guest comment authorization by a riddle
- supports the sidebar navigation
- full-text / attribute search, calendar view
- Atom feed

- **flexible customizability**

- thorough separation of logic and presentation
- template file to generate the output
- server side scripting by the Lua extension
- post processing by outer commands

Example Code

```
#! Introduction to Tokyo Cabinet
#c 2009-11-05T18:58:39+09:00
#m 2009-11-05T18:58:39+09:00
#o mikio
#t database,programming,tokyocabinet
```

This article describes what is [[Tokyo Cabinet|http://1978th.net/tokyocabinet/]] and how to use it.

@ upfile:1257415094-logo-ja.png

* Features

- modern implementation of DBM
 - key/value database
 - e.g.) DBM, NDBM, GDBM, TDB, CDB, Berkeley DB
- simple library = process embedded
- Successor of QDBM
- C99 and POSIX compatible, using Pthread, mmap, etc...
- Win32 porting is work-in-progress
- high performance
- insert: 0.4 sec/1M records (2,500,000 qps)
- search: 0.33 sec/1M records (3,000,000 qps)

Welcome, admin - [Top](#) [About](#) [Help](#) [Logout](#) [Users](#) [Files](#) [Edit](#) [Search](#)

Introduction to Tokyo Cabinet

ID: 1
creation date: 2009/11/05 18:58
modification date: 2009/11/05 18:58
owner: mikio
tags: database,programming,tokyocabinet

This article describes what is [Tokyo Cabinet](#) and how to use it.



Features

- modern implementation of DBM
 - key/value database
 - e.g.) DBM, NDBM, GDBM, TDB, CDB, Berkeley DB
- simple library = process embedded
- Successor of QDBM
 - C99 and POSIX compatible, using Pthread, mmap, etc...
 - Win32 porting is work-in-progress
- high performance
- insert: 0.4 sec/1M records (2,500,000 qps)
- search: 0.33 sec/1M records (3,000,000 qps)

0 comments

admin:

comment

innovating more and yet more...
<http://1978th.net/>

東京



キャビネット 8192 PiB